

NOTE - FOR REALIGNMENT OF PARKING SPACES SEE PARKING PLAN ON SHEET 3.

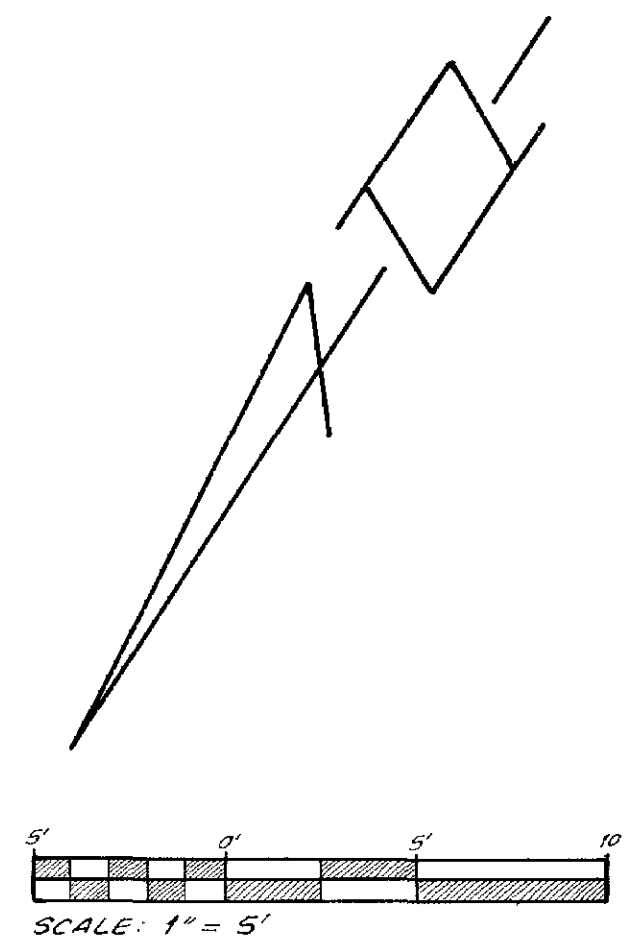

ROSS DRESS-FOR-LESS

Approved *[Signature]* City Engineer  
5-6-93

FILMS PREPARED BY <b>TIERRA ENGINEERING</b> Civil Engineering Surveying Land Planning 115 FERN AVE. SUITE 10 SAN LUIS OBISPO, CA 93401 (805) 543-1748 (805) 539-1748 FAX: (805) 781-0141		<b>DOWNTOWN CENTRE</b> HIGUERA STREET BULBOUT - LAYOUT PLAN											
DESIGN CIVIL ENGINEER <i>[Signature]</i> GORDON L. MICHAEL R.E.E. No. 38855 EXPIRES: 6-30-96 DATE OF APPROVAL: 5-6-93	CHECKED: <i>[Signature]</i> W.D. No. 2502	REVISIONS <table border="1"> <thead> <tr> <th>NO.</th> <th>DATE</th> <th>DESCRIPTION</th> <th>APPROVED CIVIL ENGR.</th> <th>APPROVED CITY ENGR.</th> </tr> </thead> <tbody> <tr> <td>1</td> <td>Δ</td> <td></td> <td></td> <td></td> </tr> </tbody> </table>	NO.	DATE	DESCRIPTION	APPROVED CIVIL ENGR.	APPROVED CITY ENGR.	1	Δ				SHEET <b>1 of 3</b>
NO.	DATE	DESCRIPTION	APPROVED CIVIL ENGR.	APPROVED CITY ENGR.									
1	Δ												

PLAN  
 SURVEYED  
 NOTE BOOK  
 REVISIONS  
 BY: [ ]  
 DATE: [ ]

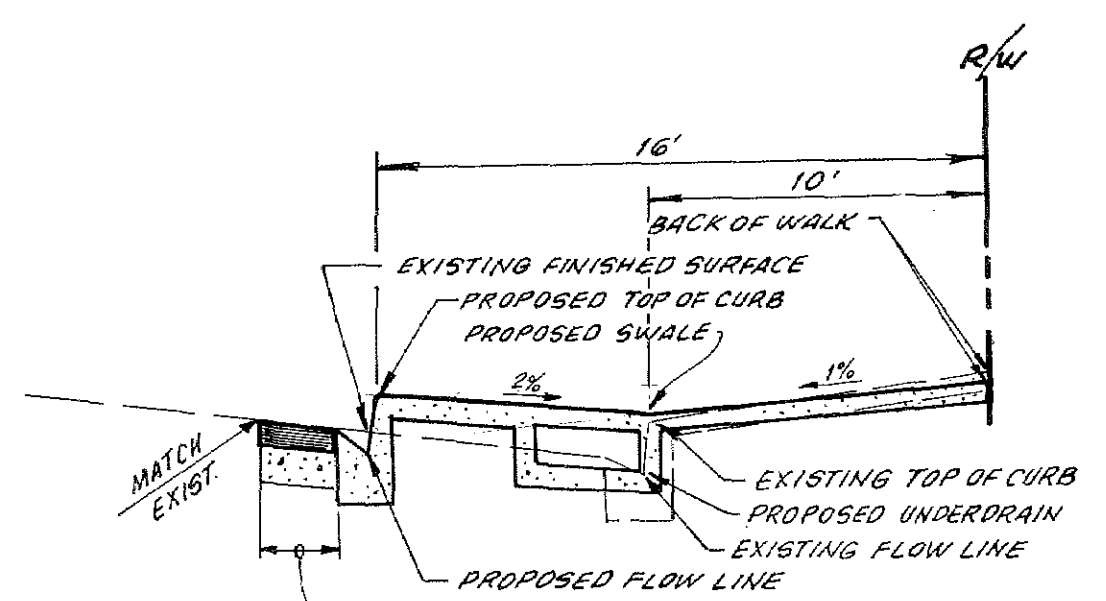
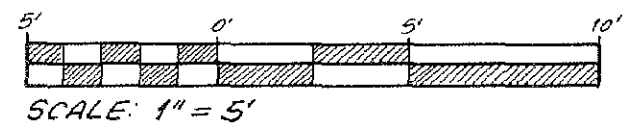

GUTTER CONSTRUCTION ADJACENT TO EXIST. A.C. SHALL INCLUDE SAWCUTTING, REMOVAL AND REPLACEMENT OF PAVING 18" MIN. FROM NEW EDGE OF GUTTER, MATCH EXIST. PAVEMENT SECTION. ALSO MATCH UNDERLYING CONC. SECTION 4" MIN. 8" THK., DOWEL TO EXIST.

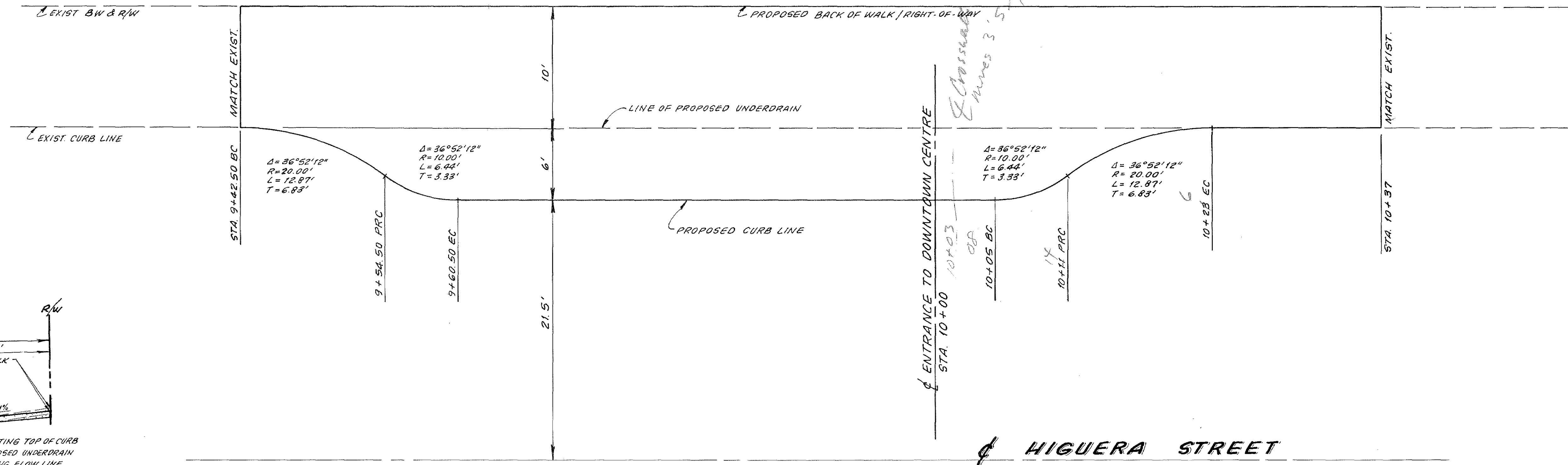

PROFILE  
 SURVEYED  
 NOTE BOOK  
 REVISIONS  
 BY: [ ]  
 DATE: [ ]

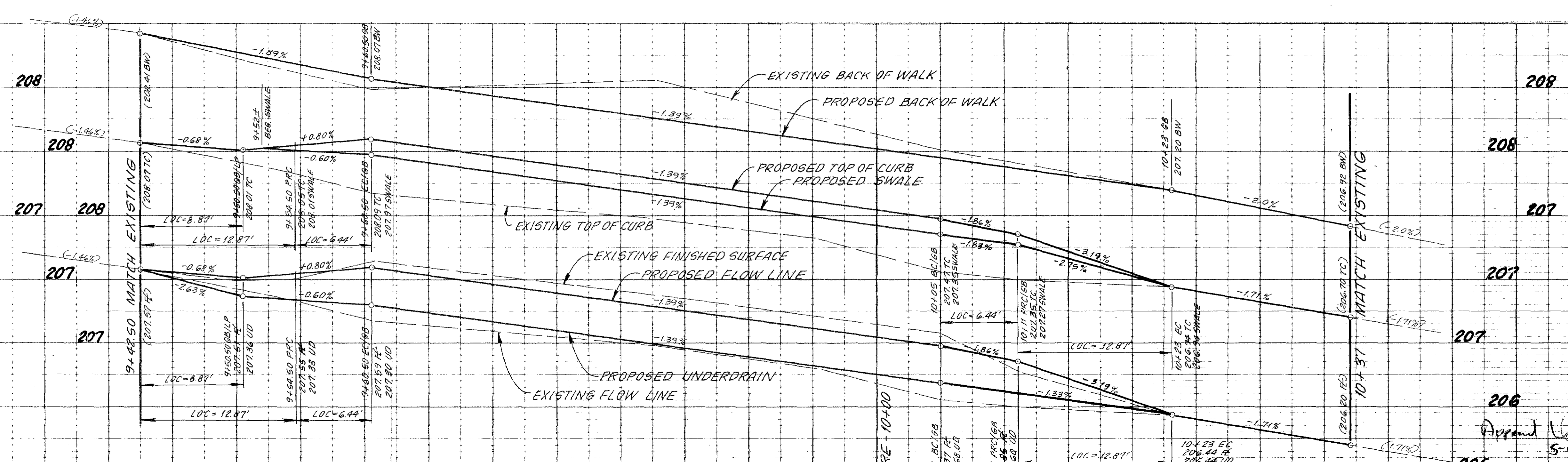

PROFILE SCALES:  
 HORIZ. 1" = 5'  
 VERT. 1" = 0.5'

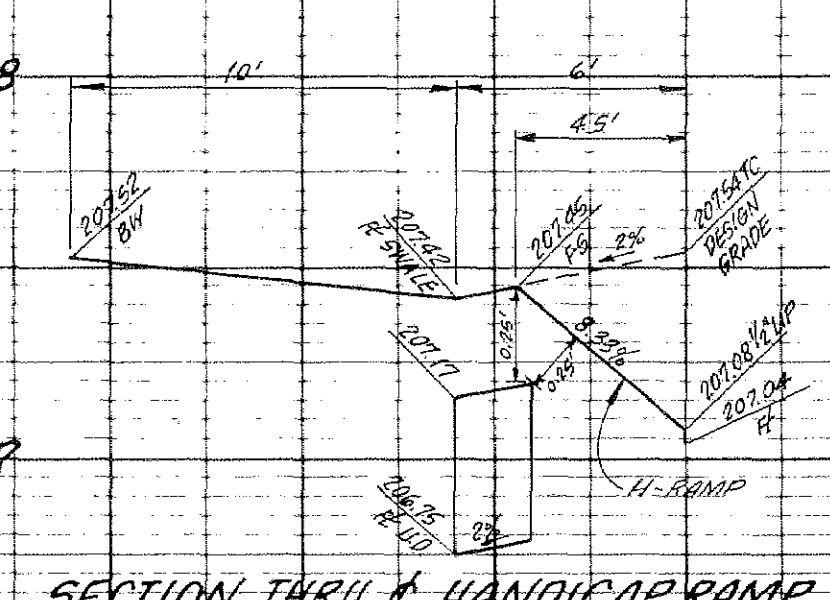

DESIGNED BY: [ ]  
**TERRA ENGINEERING**  
 Civil Engineering • Surveying • Land Planning

DESIGN CIVIL ENGINEER  
 GERALD L. MICHAEL  
 R.C.E. No. 36899  
 EXPIRES: 6-30-96  
 DATE OF APPROVAL: [ ]

**DOWNTOWN CENTRE**  
 HIGUERA STREET BULBOUT - PROFILE

REVISIONS		APPROVED CIVIL ENGR.	APPROVED CITY ENGR.
Δ	DESCRIPTION:		

SHEET: 2 of 3



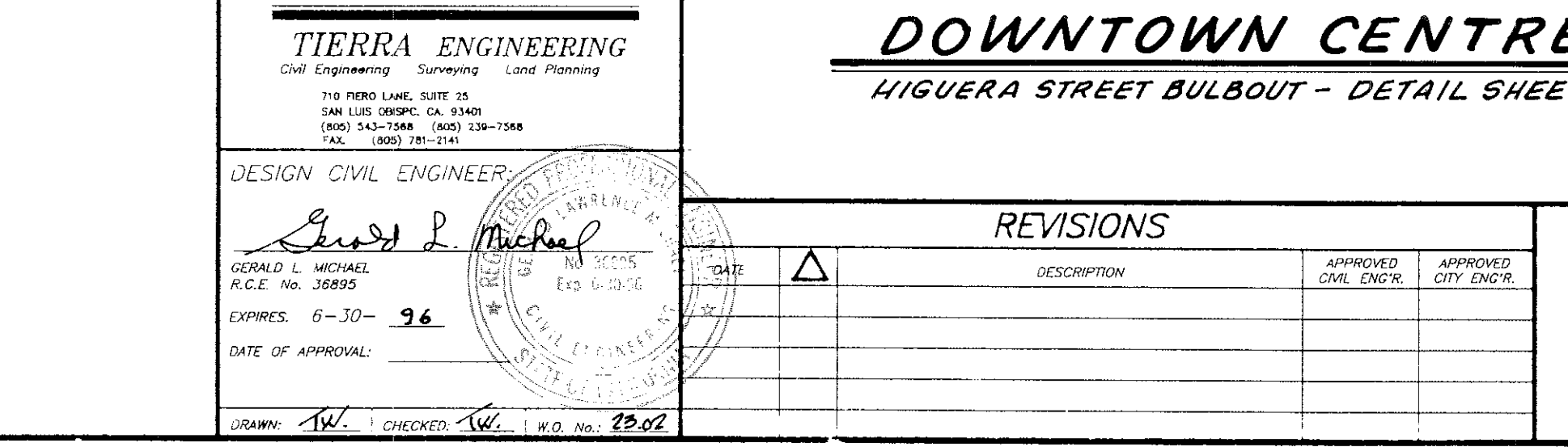
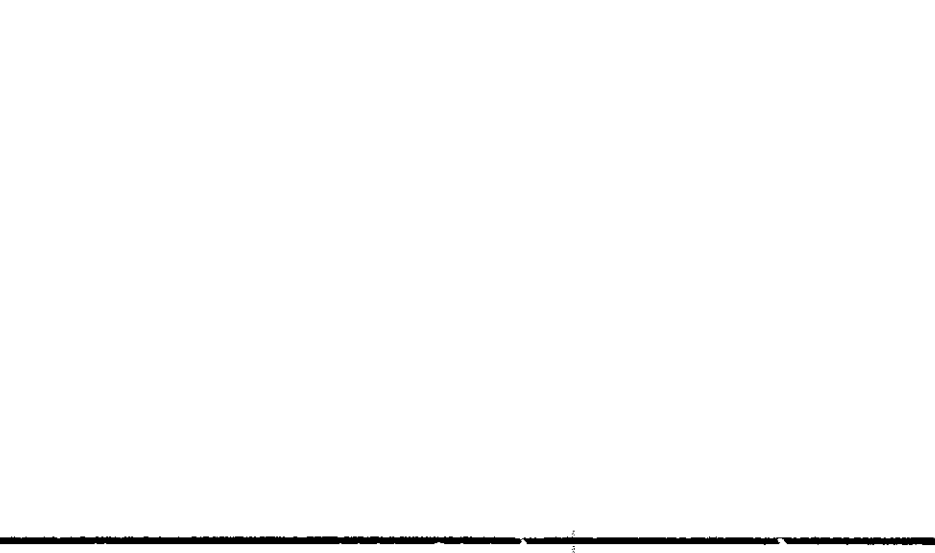
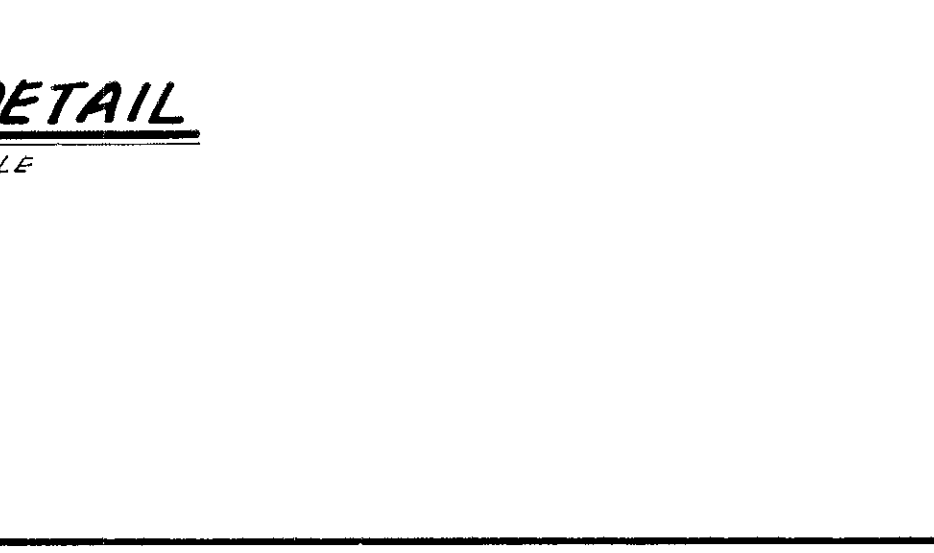
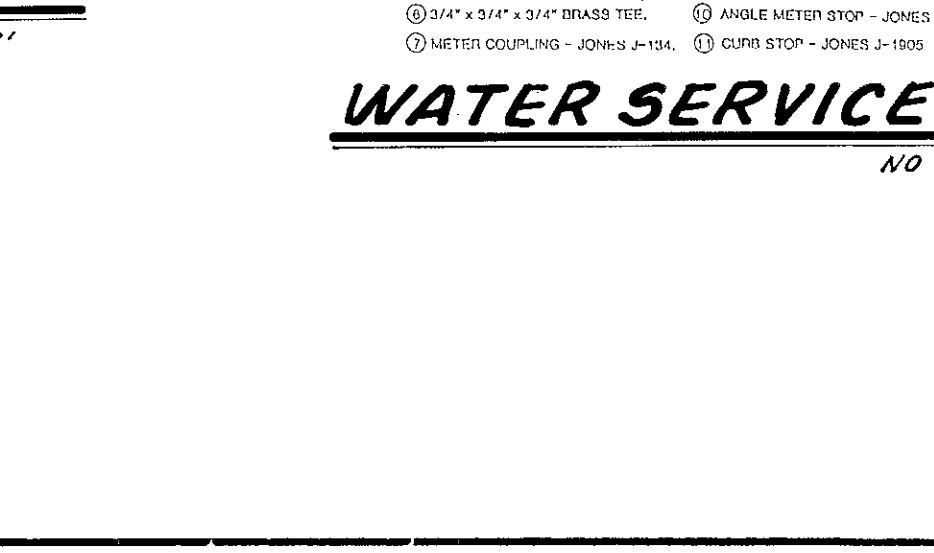
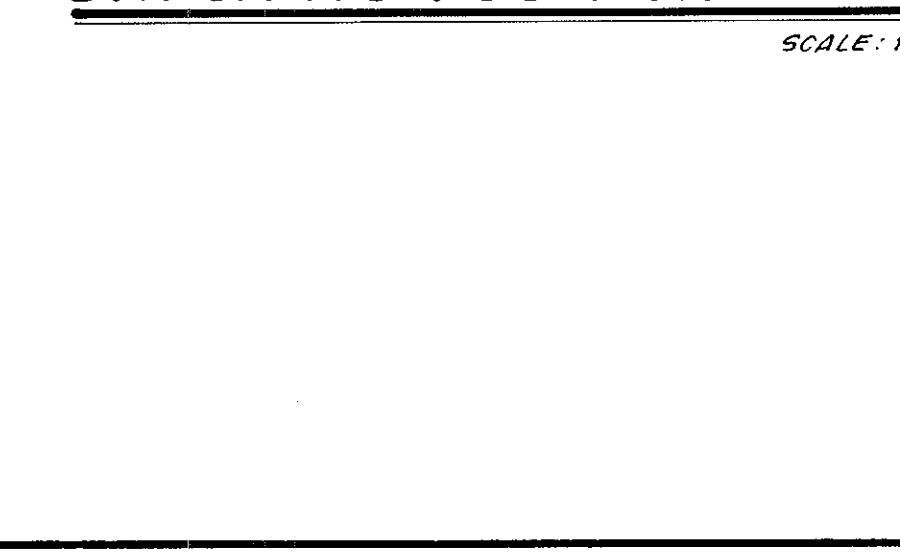
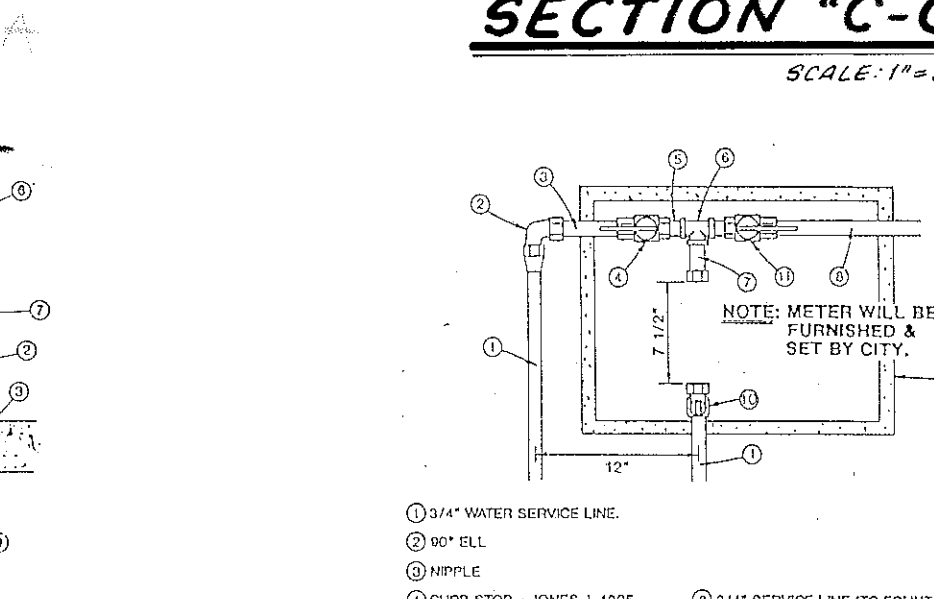
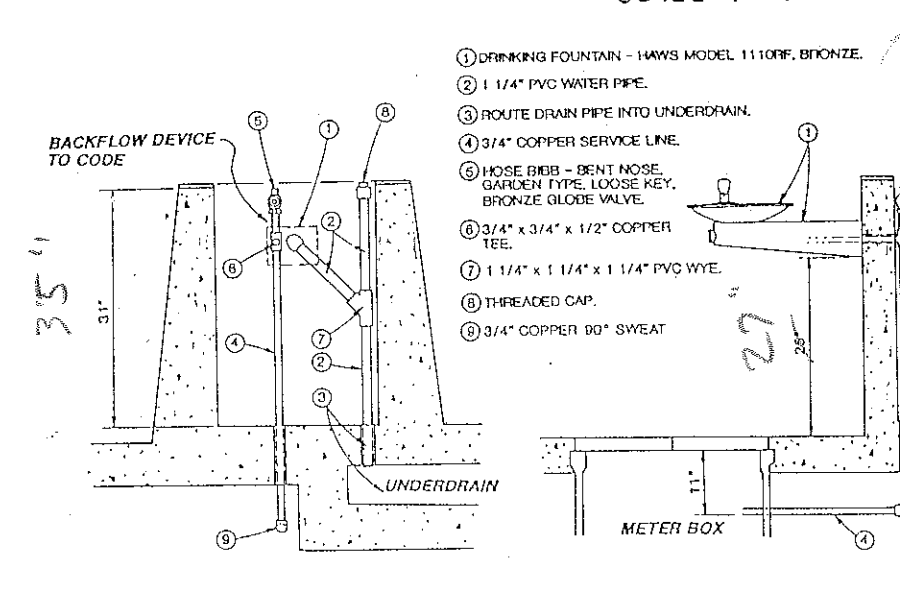
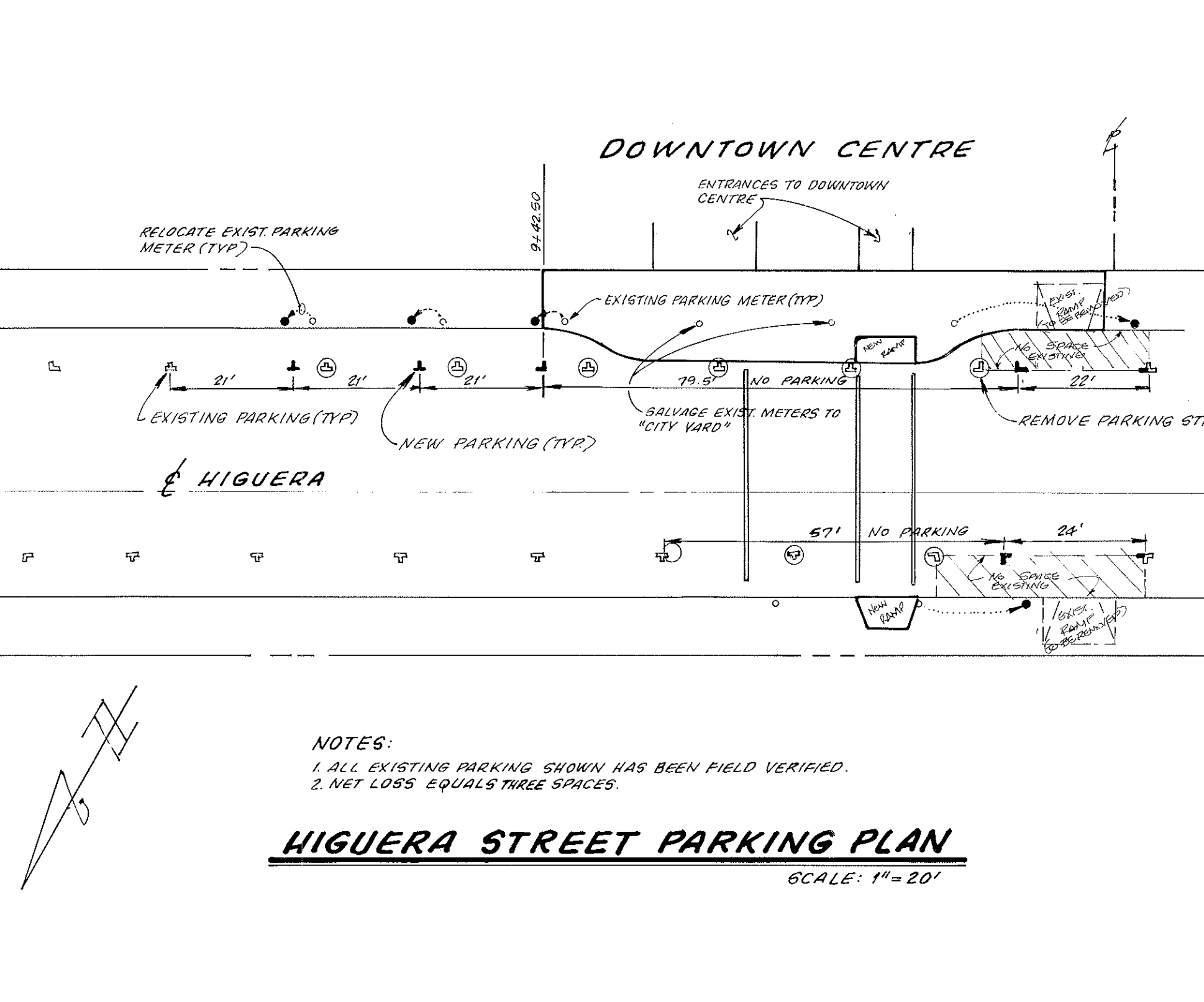
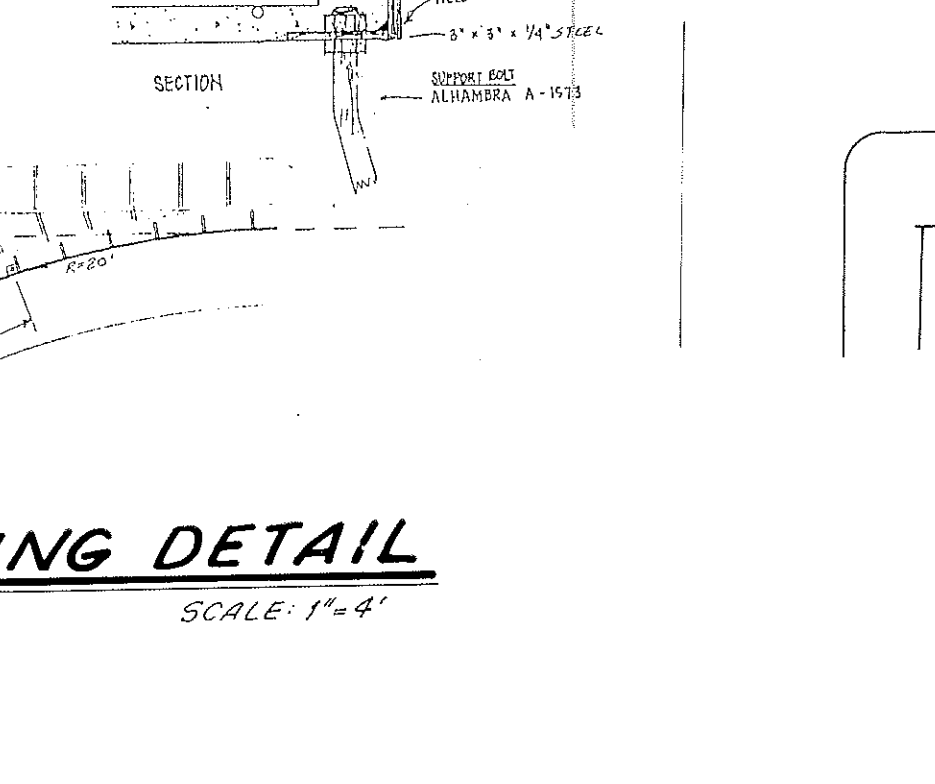
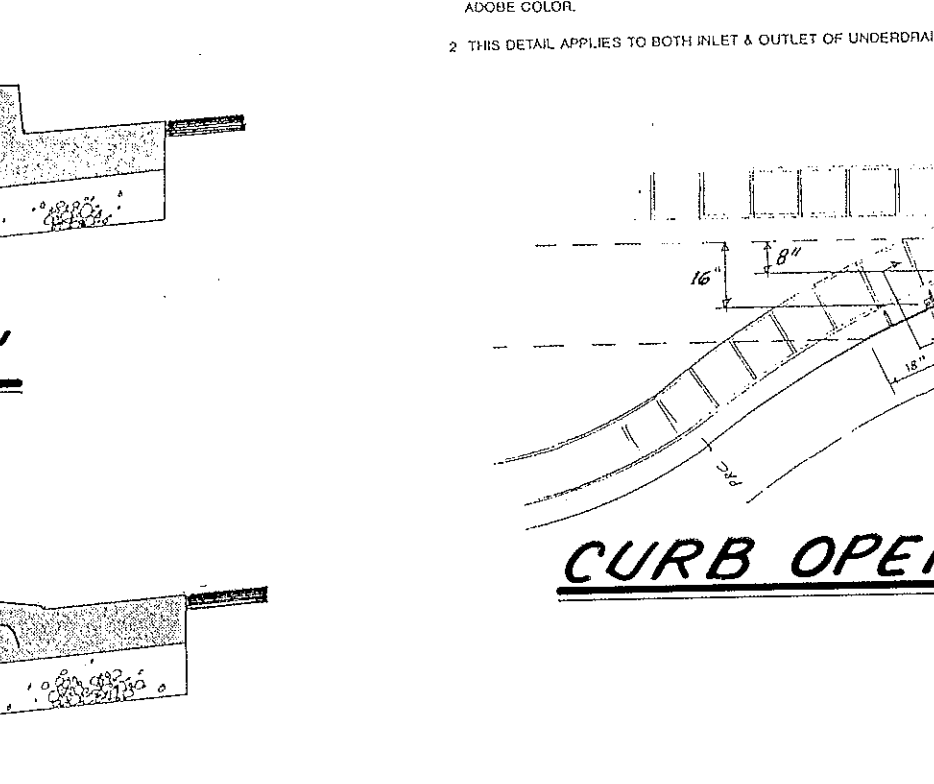
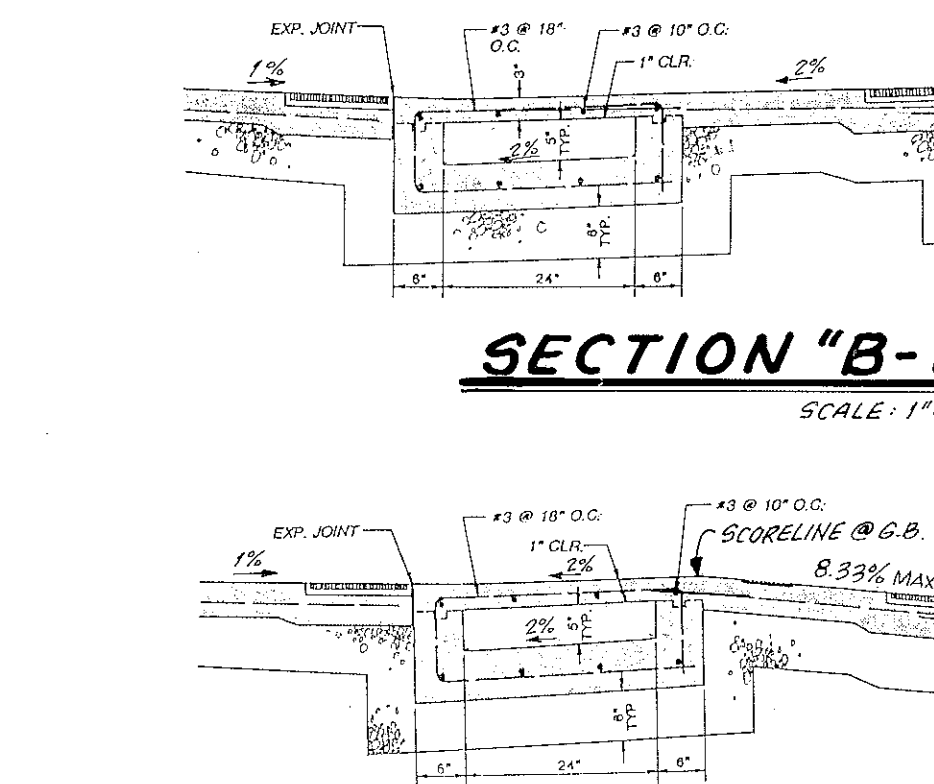
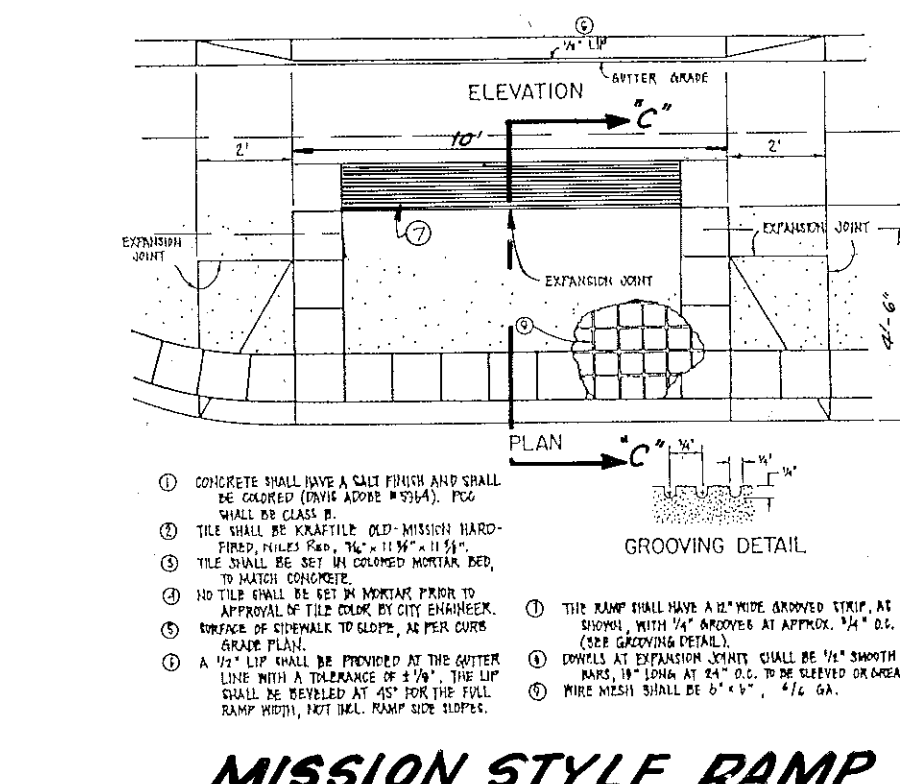
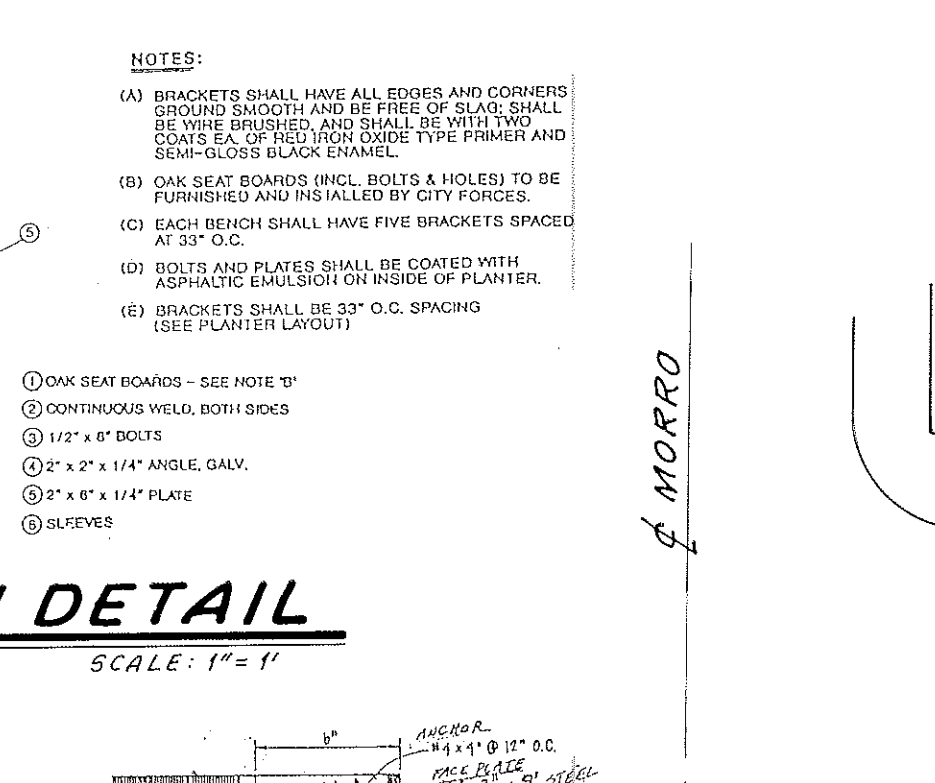
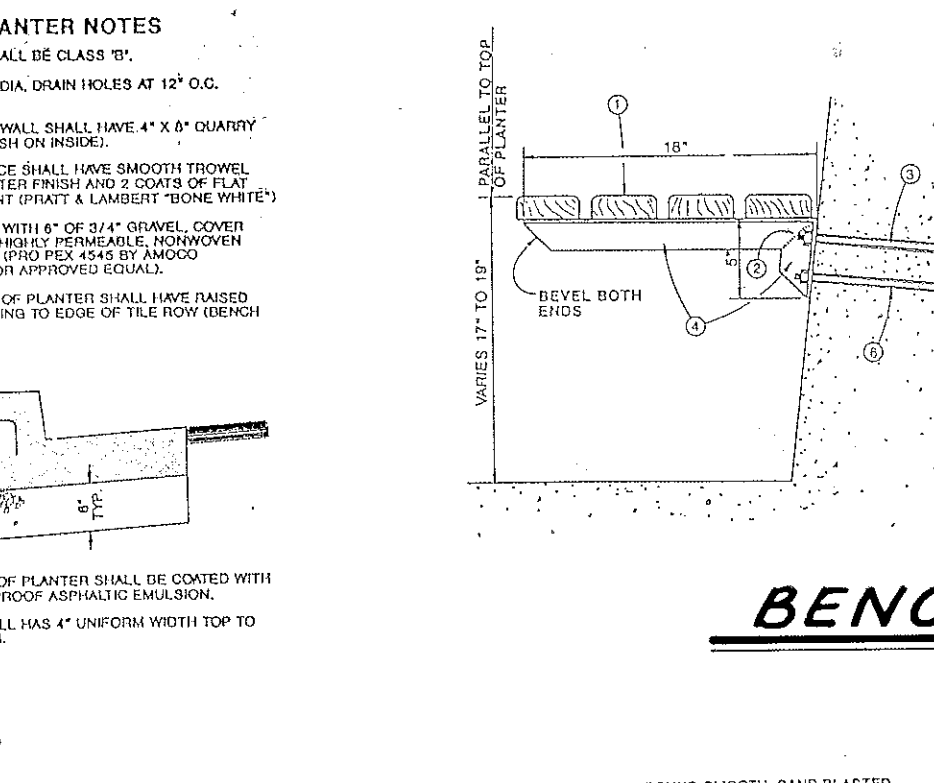
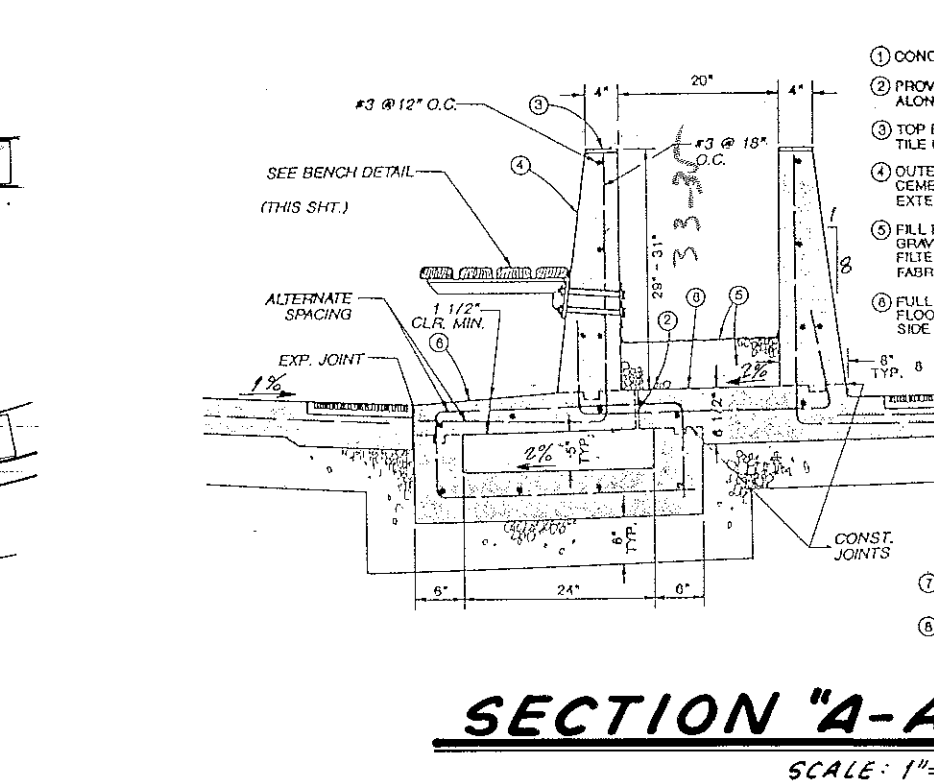
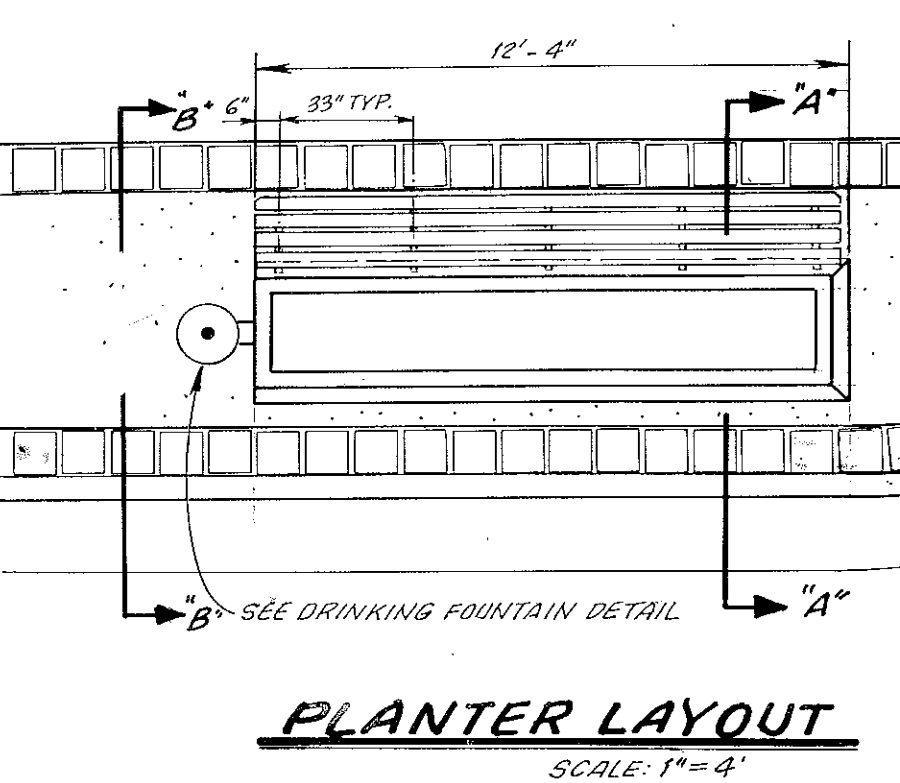
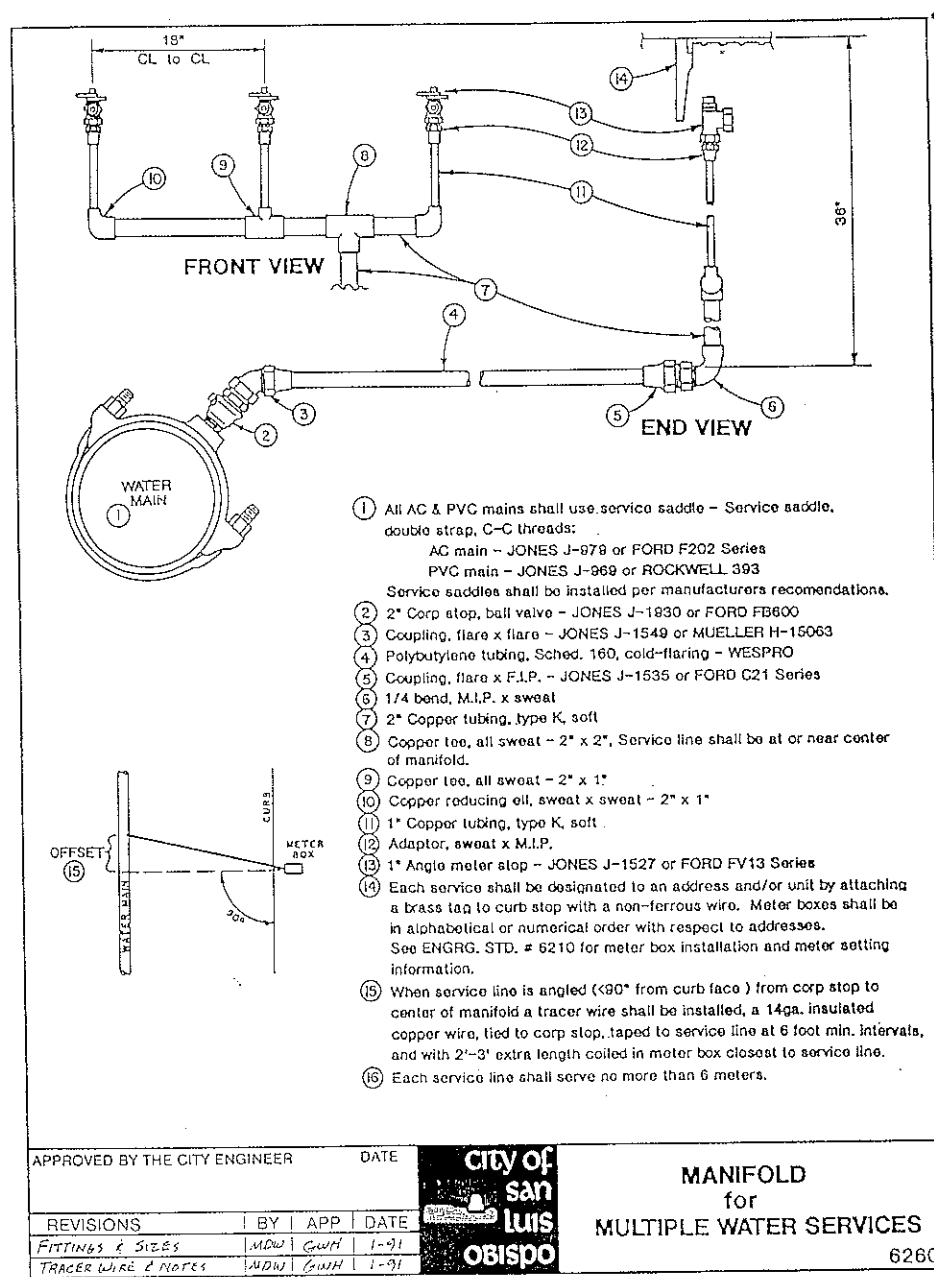
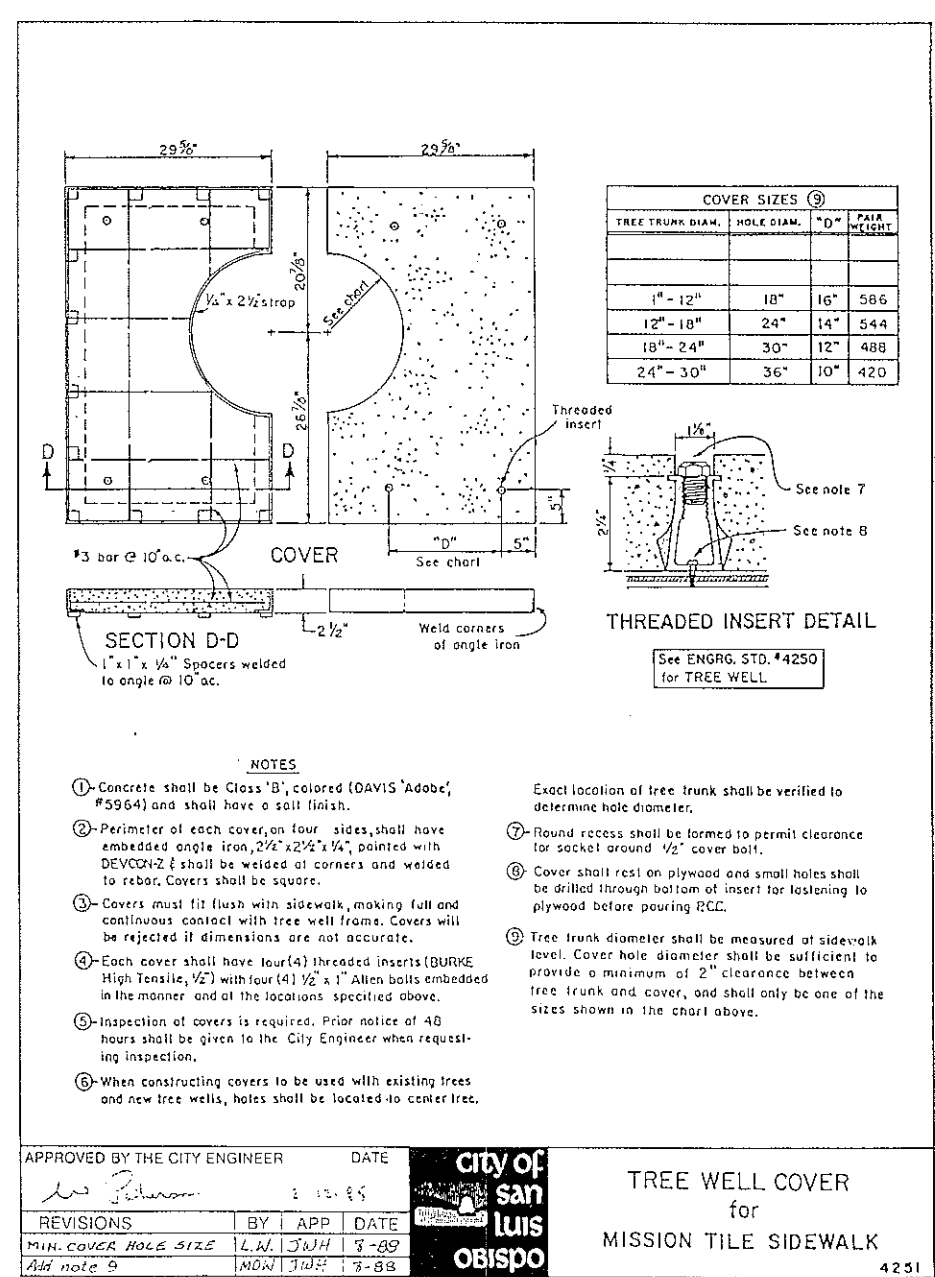
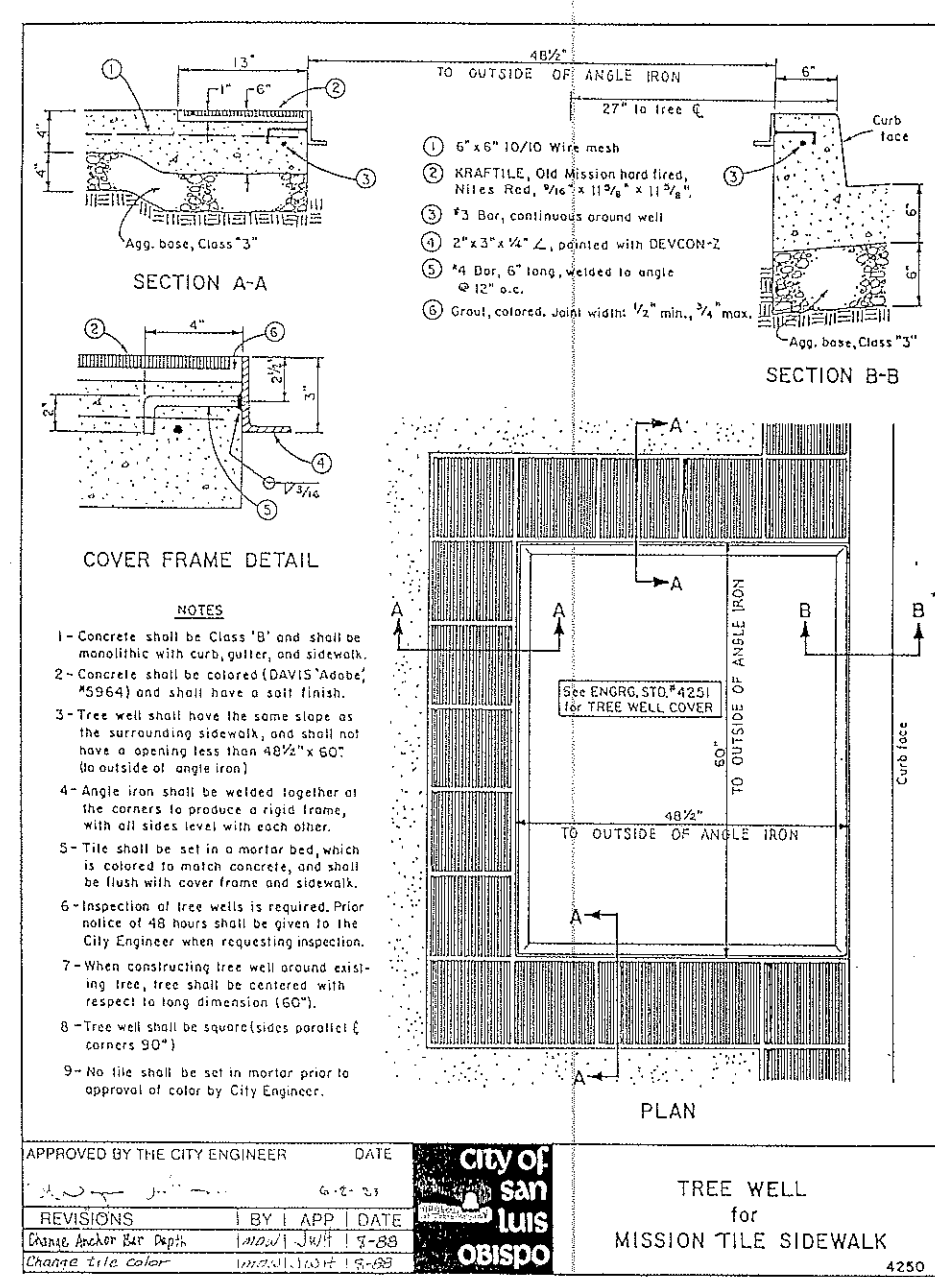
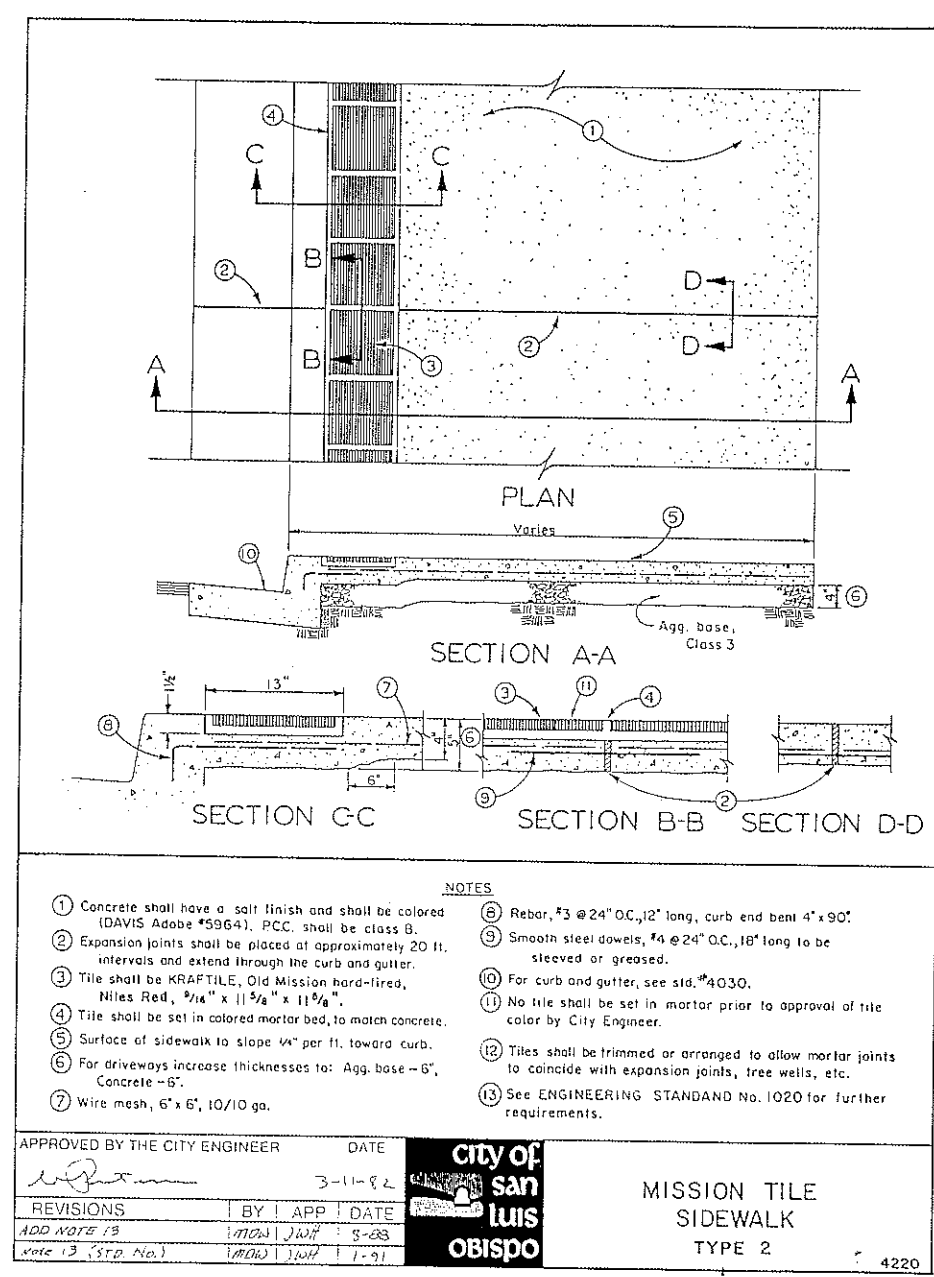
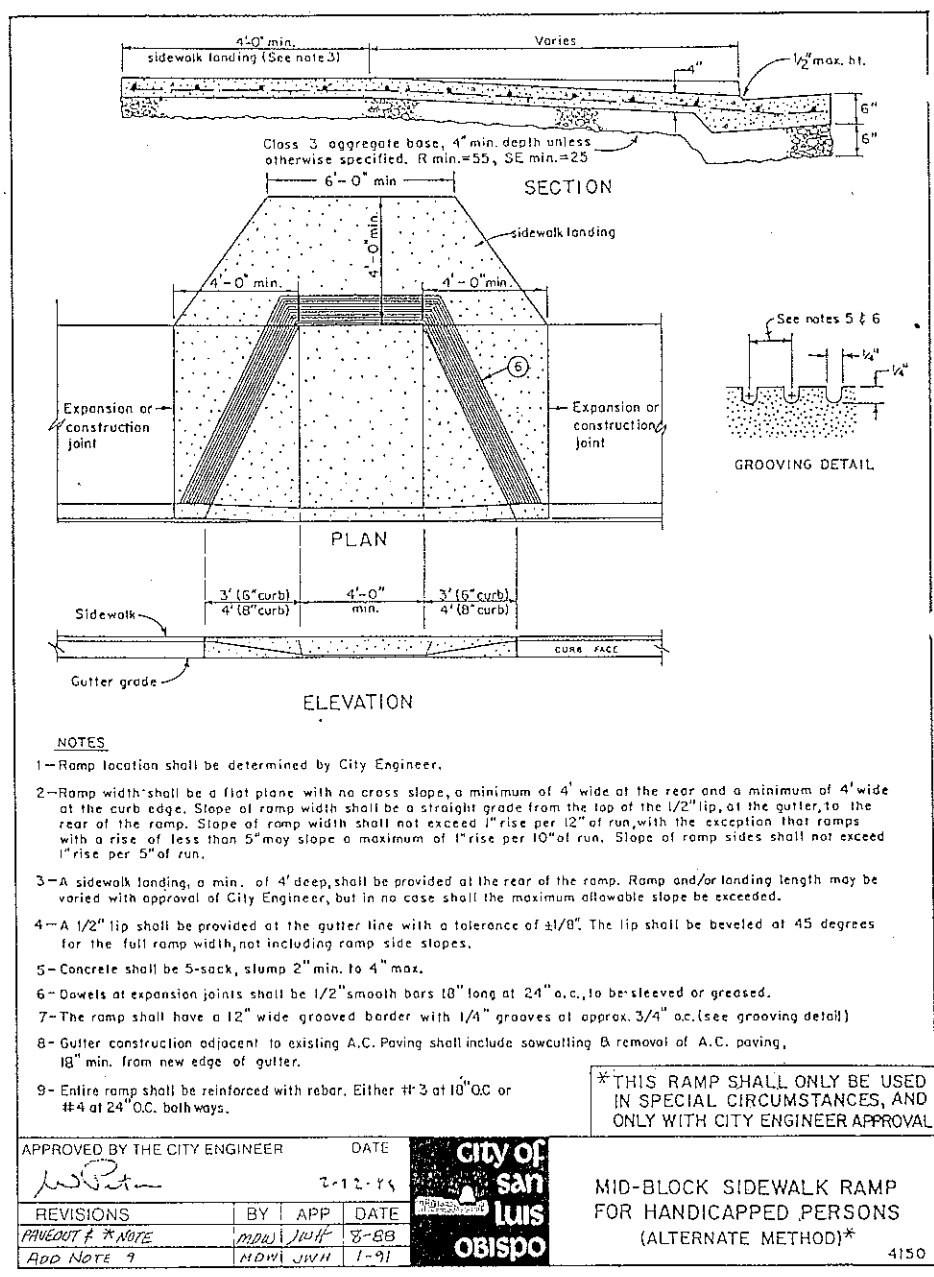
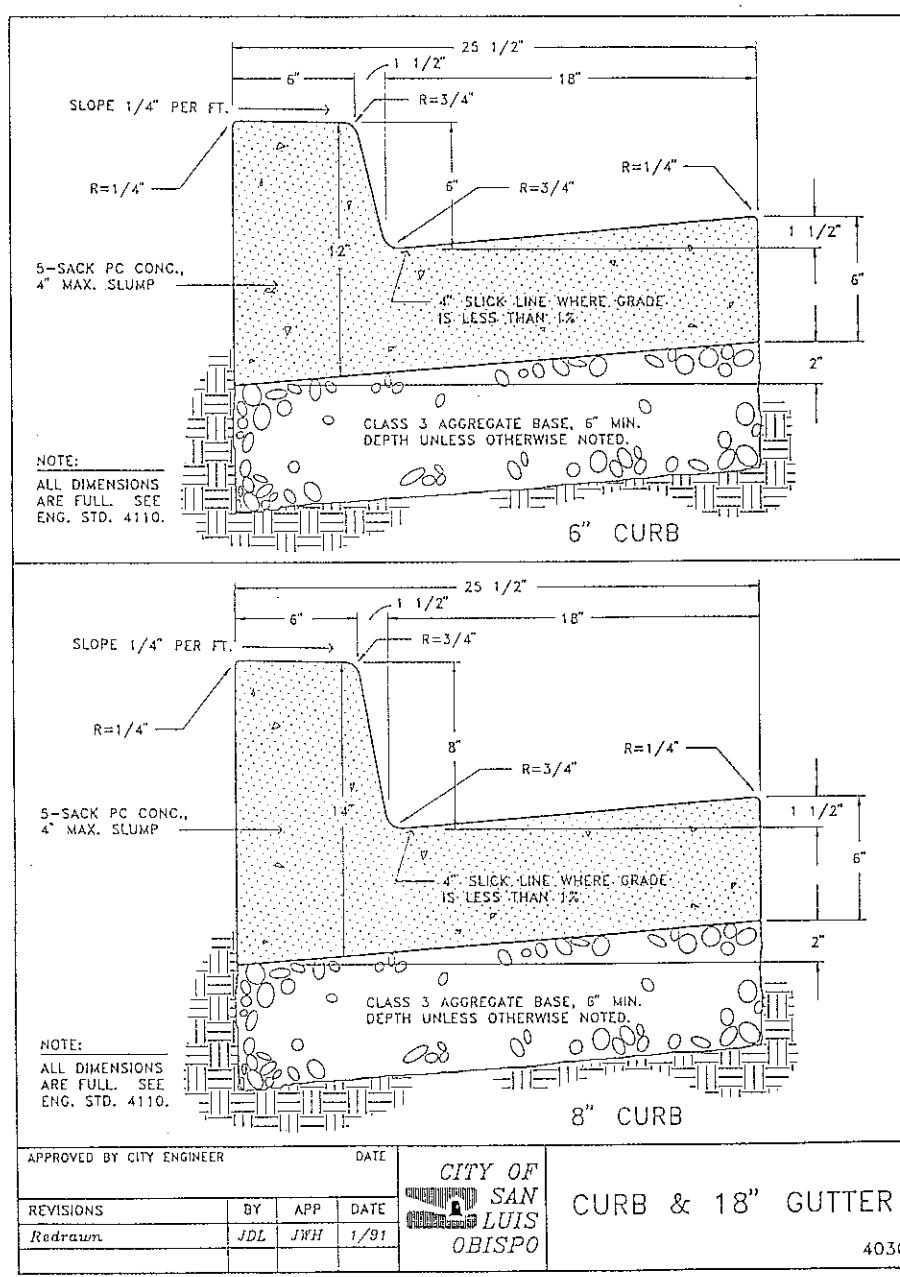

PLANS PREPARED BY:

**TIERRA ENGINEERING**  
Civil Engineering, Surveying, Land Planning  
710 PIERCE LANE, SUITE 110  
SAN LUIS OBISPO, CA 95065  
(805) 543-7344 (805) 538-7568  
FAX (805) 538-7344

DESIGN CIVIL ENGINEER:  
*Donald L. Michael*

REVISIONS:

NO.	DATE	DESCRIPTION	APPROVED (DESIGNER)	APPROVED (CITY ENGINEER)
1	6-30-96	ISSUE FOR PERMITS	<i>Donald L. Michael</i>	

DATE OF APPROVAL: 6-30-96

URBAN: *SW* CHECKER: *SW* I.D. NO.: 2802

**DOWNTOWN CENTRE**  
HIGUERA STREET BULBOUT - DETAIL SHEET

SHEET 3 of 3